

COVID-19 AIoT INFECTION PREVENTION SYSTEMS

Taiwan Vendor Review

Taiwan is a Global Leader in Infection Prevention Technologies

Executive Summary

Taiwan is a Global Leader in Managing the Pandemic with only 7 Deaths and Minimal Contagion

Taiwan is Emerging as a Global Leader in Industry 4.0, AIoT and Infection Prevention Technologies

Over 20 Local Companies Presented their New-to-the-World Solutions for Detection and Mitigation of Covid-19

New Technologies include Face-Mask Detection, Facial Recognition, Temperature and Social Distance Monitoring

Taiwan Vendors are Fully Operational and Can Immediately Export Their Surveillance & AIoT Detection Systems Around the World



Learn more from our recent article in Taiwan Business Topics Magazine: [Battling COVID-19 with Technology](#)

ABOUT THE AUTHOR - Daniel S. James II, MSEE, MBA

Daniel is the founder of ArcTiv Technologies & co-founder of Olympia International Consulting. He brings over 15 years of experience in both the data center and industrial automation industries having worked for Fortune 500 technology companies in various roles including Corporate Strategic Planning, M&A, Product Management and International Sales & Marketing. He currently resides in Taipei, Taiwan.



Who are the Taiwanese vendors with Covid-19 Mitigation Technologies?

Vendor Comparison

Companies & Technologies Evaluated in This Report



Infection Prevent Systems

- Entrance Device with Facial Recognition & Temperature Screening
- AI Enabled IP Camera
- AI Edge Computing Box



Infection Prevention System with Video AI Integrated System

- Occupancy Monitoring
- Video Thermal Screening
- Social Distancing Monitoring



AI Temperature Measurement Solutions

Taiwanese AIoT Vendors



ABOUT THE AUTHOR - Daniel S. James II, MSEE, MBA

Daniel is the founder of ArcTiv Technologies & co-founder of Olympia International Consulting. He brings over 15 years of experience in both the data center and industrial automation industries having worked for Fortune 500 technology companies in various roles including Corporate Strategic Planning, M&A, Product Management and International Sales & Marketing. He currently resides in Taipei, Taiwan.



System Overview



8" Touch Screen



NVR

Product Overview:

- 8 inch LCD Touch Screen
- Stand-Alone Device, Ready for Networking (via 8-Channel NVR)
- High-Accuracy IR Body Temperature Measurement
- Non-Contact Body Temperature Measurement
- Human-Sounding Voice Prompt
- Real-Time Face Mask Detection
- Precise Face Recognition with Mask On
- Face Liveness Detection Identifies Non-Real Face Spoof Attacks
- Highly Accurate Face Recognition Using Deep Learning Algorithm
- Real-Time Statistics

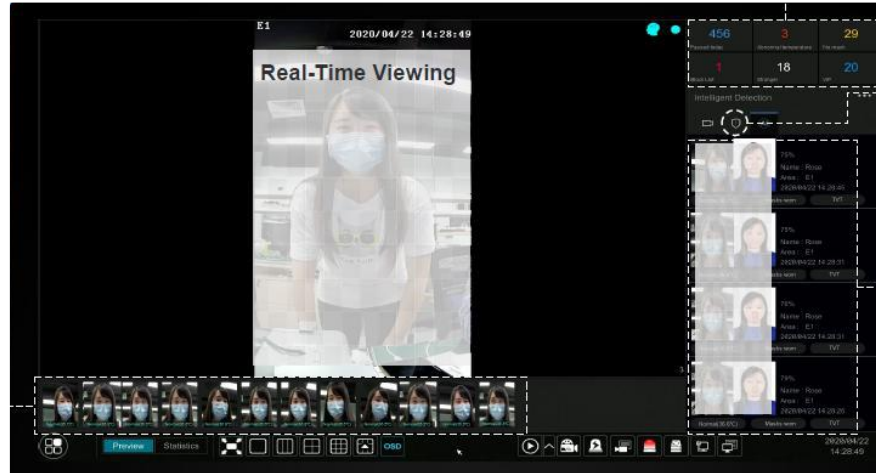

Real-Time Monitoring & Statistics

Made In Taiwan



Key Applications



Campus Entrance



Apartment Entrance



Factory Entrance



Office Building Entrance

System Overview



Made In Taiwan



Product Overview:

- Improve Performance / Reduce OPEX
- nVidia Jetson TX2/Nano open platform
- Sensor board 2MP HDR 30FPS DC Iris
- IPC base with CMOS sensor
- OEM/ODM available
- Edge computing



Key Applications

<p>Tripwire</p>	<p>Object Removal</p>	<p>Abandon Object</p>	<p>Intrusion</p>	<p>Face Recognition</p>
<p>Line Crossing</p>	<p>People Counting Analysis</p>	<p>Tampering Detection</p>	<p>Licence plate Recognition (to be released in 2020)</p>	<p>Crowd Density</p>

System Overview

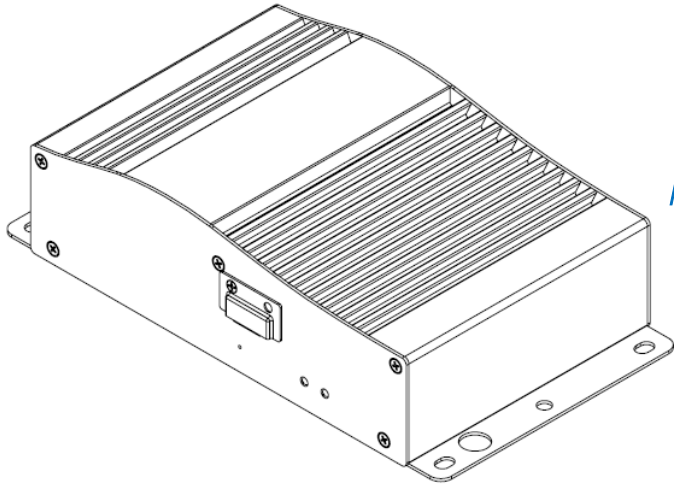

Made In Taiwan

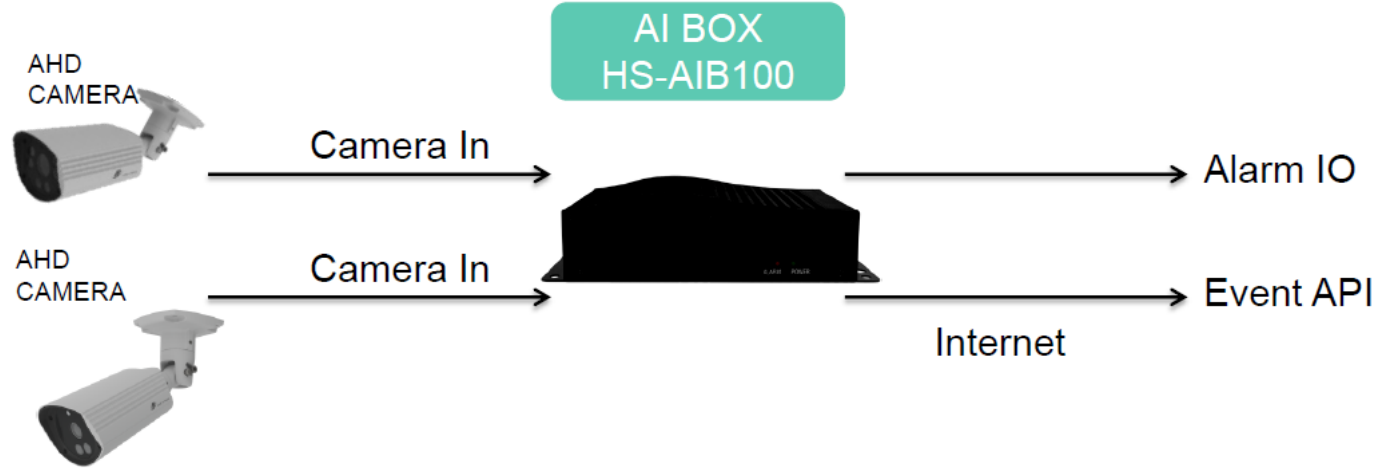

Legacy IP camera's can use backend "AI Box" to have IVS functionalities.

Product Overview:

- AI low speed ANPR
- AI human shape recognition
- AI elevator
- AI traffic counting; traffic flow counting (direction, period)
- Vehicle parking space counting

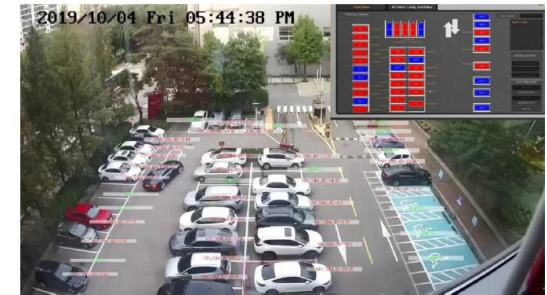
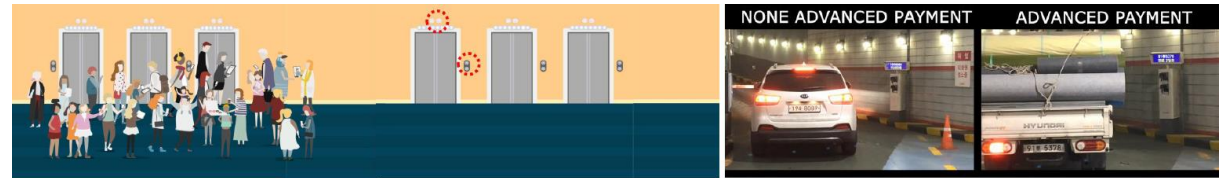

System Overview

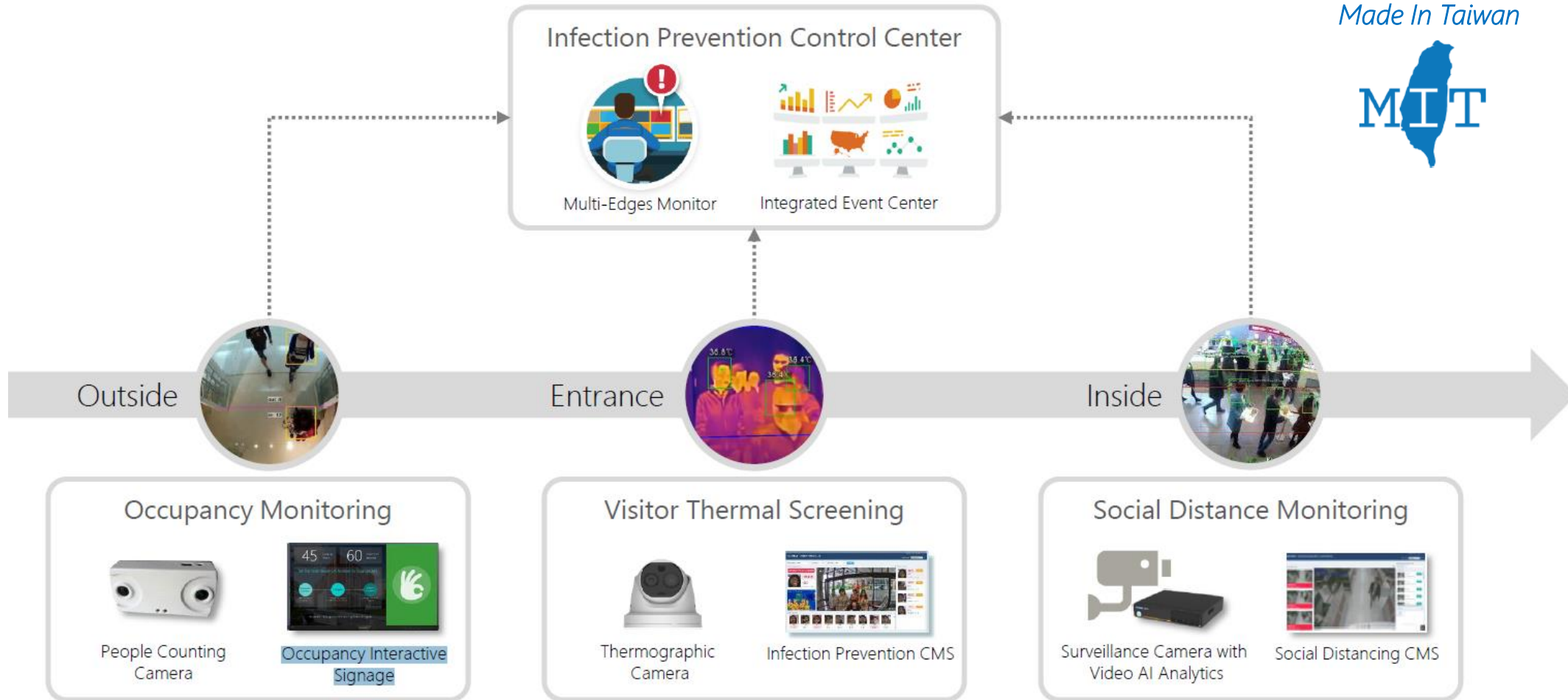

System Overview

Product Overview:

- Live occupancy data in your building from multiple counting cameras
- Integrated digital signage for flexible visual warnings design
- Quick checking and configuration with Occupancy Mobile APP
- Cloud Report Dashboard for further analysis

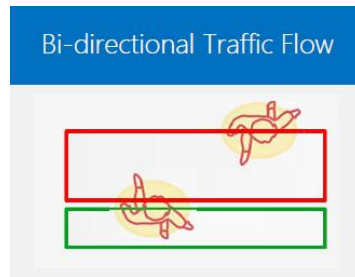
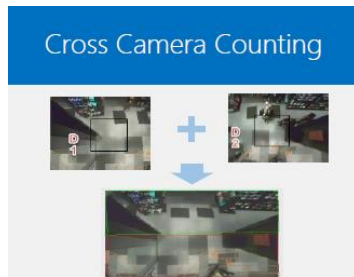
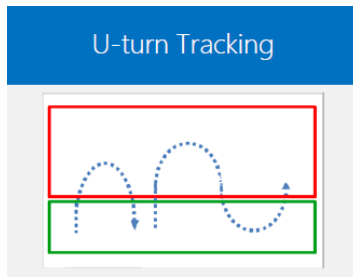
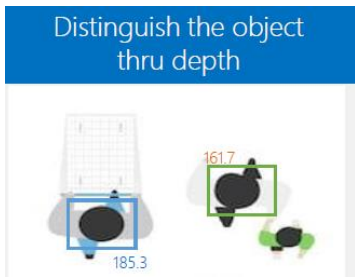
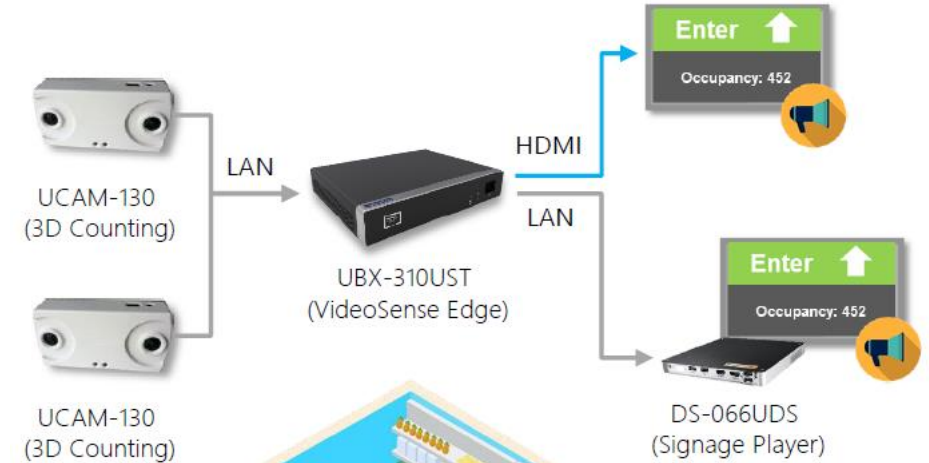
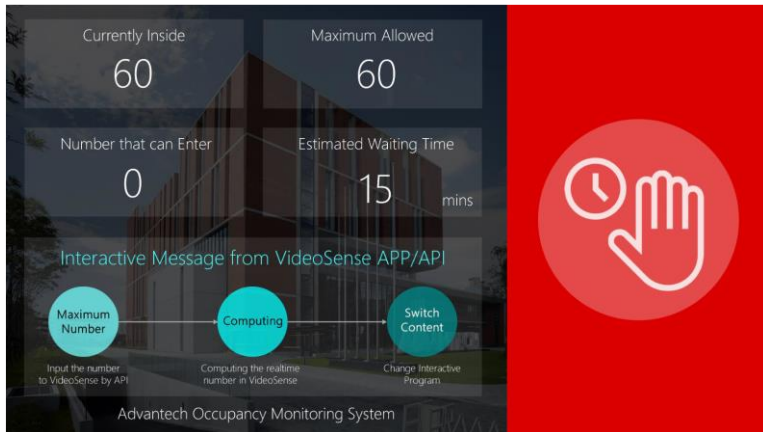

System Overview

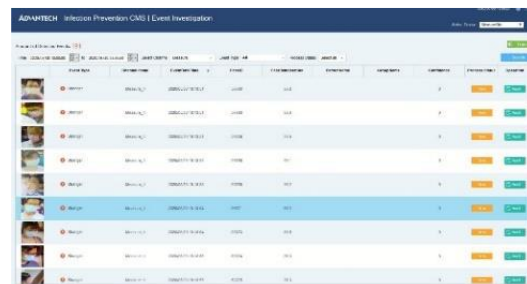

Thermal Screening

- Visitor face with body temperature display
- History list for visitor with fever symptom
- Fever screening result update after re-testing
- Multiple cameras display mode
- Facial recognition
- Auto enroll the visitor face with fever symptom

Dashboard

- Event statistic summary
- Event cross comparison by location and event type
- Event trend analysis by day/week

Event Investigation

- Event statistic summary
- Event cross comparison by location and event type
- Event trend analysis by day/week

Turret Type



UCAM-220TT
(Lens: 3mm/6mm)

Bullet Type



UCAM-220TB
(Lens: 6mm)

Black Body



System Overview

Six Feet Away



Coronavirus TRANSMISSION



Product Overview:

- Monitor people's locations in real time
- Enforce social distancing policies that dictate at least six feet of separation.
- Easy setup & calibration setting for detect with different camera installations.
- Exception event generated automatically for checking and auditing quickly
- Alert distance can be adjusted in setting page
- Sustained time for exception event can be adjusted in setting page
- Search the abnormal event detected and check the details by video playback
- Analysis Summary for investigation result recording
- Event history export

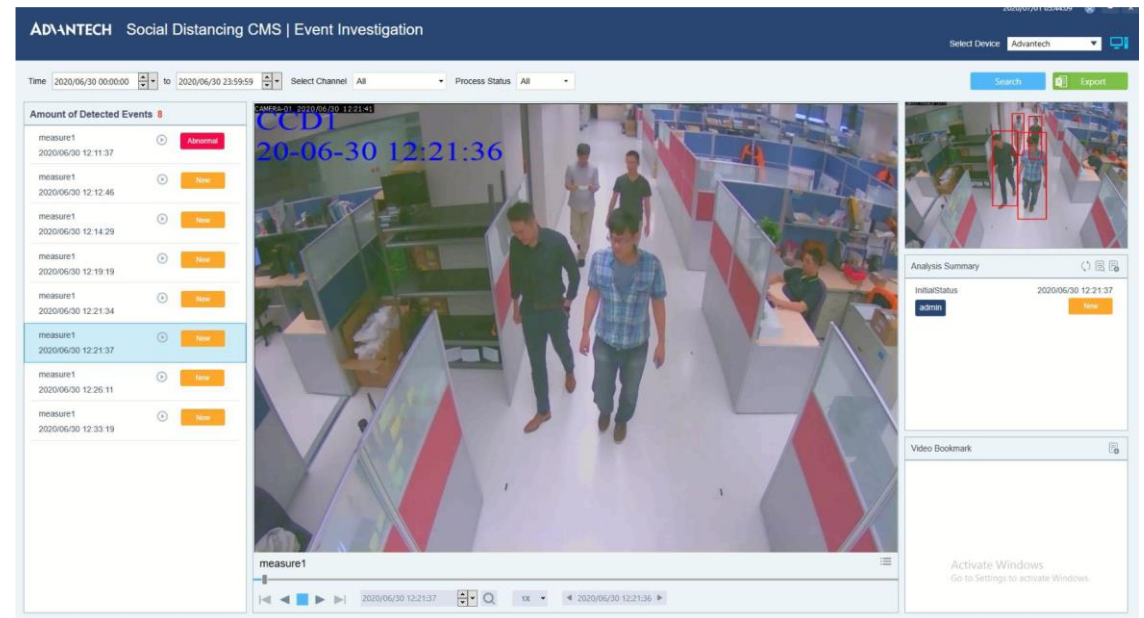

LILIN AI Temperature Measurement Solutions

System Overview

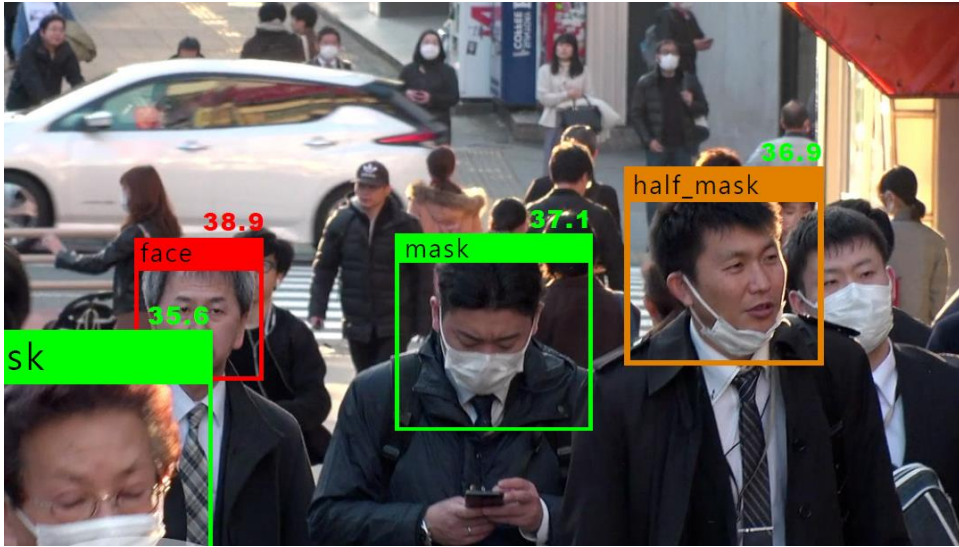

Video Screen



NVR



AI Mask Detection



Temperature Measuring IP Camera

Use Cases



School



Public Transportation



Office



Hospital



Factory



Retail

Product Overview:

- Allows instant and accurate face temperature monitoring
- Face temperature measurement – reduce false positives by only measuring face.
- Temperature Measuring System include cameras, NVR, NAV, AI Mask Detection solution.
- NAV live video and temperature reading integrates with AI mask detection.
- Once the temperature reaches threshold, NAV recorder can support alarm snapshots.
- Play pre-record warning message or trigger digital output.
- Video play and event search.

Olympia Technology Consulting Services

Overview



Olympia International Consulting technology services can provide you with in-depth analysis of Taiwan technologies, vendors and trade shows to help your business excel and navigate through turbulent market conditions. To learn more [book a free 15-minute call](#) or email us at contact@olympiai.com

Our Taiwan Technology Consulting Services Include:

Southeast Asia Supply Chain Reports

- Vendor Evaluation & Site Visit
- Market Trends

Technology Reports & Application Studies

- Product Review & Analysis
- Vendor Analysis

Taiwan Trade Show Report

- Video Summary of Product Demo's
- Show Report & Summary of Speaker Events



Our Mission is to Empower Businesses & Professionals to **Shine on the Global Stage**

We provide services to help professionals in Southeast Asia and around the world to **take action** and position their businesses and careers for success. Learn more about how our team of experienced international consultants can help you quickly navigate in this dynamic environment.

Contact Information

Olympia International Consulting, Ltd.
15F., No. 159, Sec 1, Keelung Rd., Xinyi Dist.
Taipei City, 110, Taiwan (R.O.C.)
Contact@Olympiaic.com

www.olympiaic.com

September 9, 2020

Copyright © 2020, All Rights Reserved

CONFIDENTIAL: PROPERTY OF OLYMPIA INTERNATIONAL CONSULTING